

# How to build a tornado machine

for in your living room

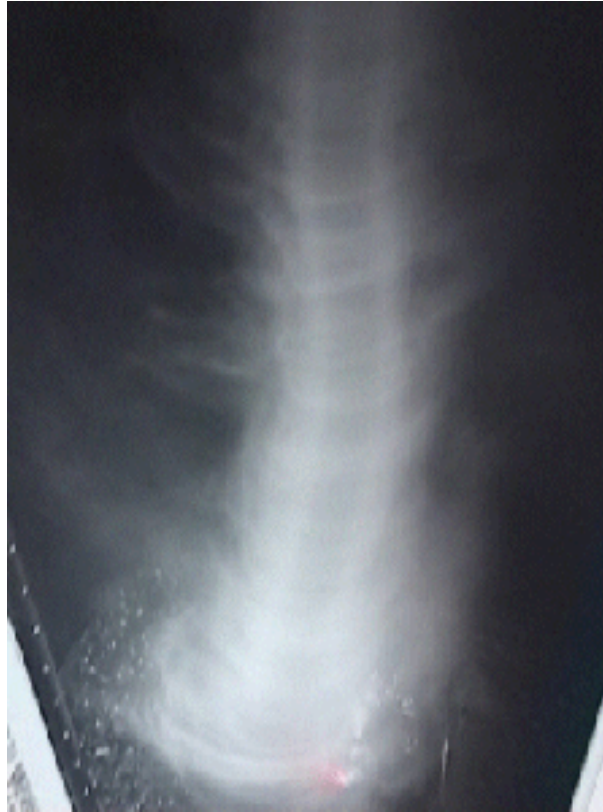

Harald E. Edens  
M.S. Physics

[www.weather-photography.com](http://www.weather-photography.com)

October 28, 2002

# Contents

<b>1</b>	<b>Copyright notice and legal disclaimer</b>	<b>3</b>
<b>2</b>	<b>Introduction</b>	<b>4</b>
<b>3</b>	<b>Working principle</b>	<b>5</b>
<b>4</b>	<b>Necessary materials</b>	<b>6</b>
4.1	Materials . . . . .	6
4.2	Tools . . . . .	7
4.3	Description of materials . . . . .	7
<b>5</b>	<b>Metric system conversion factors</b>	<b>10</b>
<b>6</b>	<b>Construction</b>	<b>11</b>
6.1	Cutting the wooden disks and support blocks . . . . .	12
6.2	Making the lower plexiglass disk . . . . .	12
6.3	Making the upper plexiglass disk . . . . .	13
6.4	Cutting the PVC sheeting . . . . .	15
6.5	Making the upper and lower compartments . . . . .	15
6.6	Preparing the PVC tube . . . . .	16
6.7	Assembly . . . . .	17
6.8	Painting . . . . .	20
6.9	Attaching the aluminum strips . . . . .	21
<b>7</b>	<b>Miscellaneous installation</b>	<b>23</b>
7.1	Installing the fan and airflow channels . . . . .	23
7.2	Installing the mist generator . . . . .	24
7.3	Installing the light . . . . .	25
<b>8</b>	<b>Finishing touches</b>	<b>26</b>
<b>9</b>	<b>Dimensional modification</b>	<b>28</b>
<b>10</b>	<b>Running the generator</b>	<b>29</b>
10.1	Operation tips . . . . .	29
10.2	Troubleshooting . . . . .	30
<b>11</b>	<b>Photos</b>	<b>32</b>

# 1 Copyright notice and legal disclaimer

All text, ideas, pictures and photos of this document are copyrighted by the author, Harald E. Edens. No part of this document may be reproduced without my explicit, prior permission in any form or medium, and may only be printed for your own personal, non-commercial, documentation and use.

The author can not and will not be held responsible for any structural damage or personal injury/death resulting from building or operating this device. The machine construction plans are provided *as-is*, and anyone attempting to build this device should be capable of foreseeing and acting upon any dangerous situations which might result from mechanical/electrical construction, and operation of this device. Danger can be but is not limited to electric shock, injuries / burns resulting from mechanical construction, short-circuit and fire. Persons who are under-age or otherwise physically or mentally limited in their use of tools required for construction, should not attempt to build this device or be supervised by a competent person.

By downloading or by other means acquiring this document you agree to conform to these copyright rules and disclaimer, will not hold the author responsible for any mishap possibly resulting from this project, and agree to only use this document for your own personal use. For any other use permission from the author must be asked in advance. The contact email is [edens@weather-photography.com](mailto:edens@weather-photography.com), or visit the website [www.weather-photography.com](http://www.weather-photography.com).

## 2 Introduction

In summer 1998 I went to Paris for a holiday. There I visited the La Cité museum, where a 3 feet tall tornado generator was setup. I was fascinated by the beauty of the tornado vortex, and the open design of the generator: I could stick my hand right through the front of the generator box, and touch the misty vortex of the tornado.

A few weeks later, at home, I designed my own generator box and built the thing, this one too with open front. When I got the generator working, the tornado it produced was of the same beauty as that one in Paris. Now I want to describe to you my design, so you can build one yourself and be amazed by the tornado. The design may also serve for research purposes.

The tornado will be about 0.9m tall (about 3 feet) when fully developed. The generator design uses a variable-speed fan, for the generator to be able to simulate the F1 - F3 range of tornado structures. At very low fan speed, the tornado will be like a rope, almost stationary positioned in the generator box. When run at high speed, the tornado will be a swirling vortex, about 130mm (5") thick, going wild in the generator.

Costs to build this generator are about \$150, mostly due to the high cost of the mist generator it uses (\$100), the fan (about \$25) and the power supply for the fan (\$20). Most of the rest of the materials will be lying about in your workshop. You can build the generator first, without buying the mist generator, to save money. You'll not have a visible tornado vortex, but you can make this visible with smoke or soldering fumes. If the device really works and a tornado is produced, you can buy the expensive mist generator.

I will assume you have some basic modelling experience, to successfully build the device. It is important to be accurate in cutting and sawing materials and the like, for it is a rather expensive project, and the generator is a tall object when setup in a living room, for example, so you'll want to let it look nice.

### 3 Working principle

A tornado consists of a low pressure core with air rotating around this core. The strength of a tornado will depend on the low pressure at the core: the lower the pressure, the more swiftly the air will rotate around it. In a real tornado, air is usually rotating with speeds of 100 km/h to 500 km/h. The strength of a tornado is measured in the Fujita scale F1 to F5. An airflow speed of about 0-100 km/h applies to an F1 tornado, and so on, to about 400-500 km/h for an F5 tornado. (This is only my observation, but the rule stands very well).

If we want to simulate a real tornado on small scale, we need to rotate air and remove the air out at the top of this circulation, to get a low-pressurized core. Since angular momentum of the air is preserved, the air rotating around will not enter the core (ideally, but as it turns out even in everyday life the momentum is preserved pretty well). So air wants to flow to the low-pressure core of the vortex but if it has rotation it will keep rotating around it, faster and faster, until equilibrium between air friction, pressure gradient and centrifugal mass-velocity is reached. For a real tornado occurring on middle latitude, air will start rotating around the core by itself due to the Coriolis force (by Earth's rotation). For small-scale tornadoes this effect is not enough to start air rotation by itself.

I used this principle of rotating air and suction at the top in my generator. Other generator designs I have seen consist of a box with a fan at the top, sucking air out of the box. Air is reentering the generator via some slots at its sides. These slots are each orientated so that the air entering will flow around the mid section of the box. This design works great but you have to look through a window at the tornado and you can't put your hands inside in a comfortable manner.

I constructed an open-design tornado generator, a cylindrical box about 0.4m in diameter, with an open front about 0.3m wide, 0.8m tall. Since this open "window" will let air in immediately, letting it flow right to the low pressure, no tornado will ever form using the slots principle described above. So I had to think of another way to let the air rotate: to use the fan at the top of the generator not only for suction, but also for blowing the air back in the generator again, by means of a punched PVC tube at the side of the generator. This tube I positioned so to blow the air entering at the open front sideways. This way the open front of the generator acts as one huge slot. If you're sceptical, I need to say I constructed this design and it works pretty well, even when putting my hands in the slot.

## 4 Necessary materials

### 4.1 Materials

To build the generator I used the following materials:

- 2 plywood or MDF disks, 18mm thick, 400mm in diameter
- 2 plexiglass disks, 2mm thick, 400mm in diameter (DO NOT cut these - yet)
- 16 wooden blocks, length 150mm, 18mm × 60mm cross-section
- 1 PVC sheet, 1200mm × 1000mm, 1mm thick
- 1 PVC sheet, 300mm × 175mm, 1mm thick
- 1 PVC sheet, 300mm × 250mm, 1mm thick
- 1 (radial) blower fan, power rating / air throughput approximately that of a vacuum cleaner
- 1 power supply for blower fan (optional - depends on the fan you use)
- 1 RPM driver for blower fan
- 1 mist generator
- 1 PVC pipe, length 1000mm, 32mm thick
- About 30 bold-head screws, 30mm - 40mm long, and washers
- 16 flat-head screws, 30mm - 40mm long
- 8 small rivets
- 2 aluminum strips, 2mm × 10mm cross-section, length 1200mm
- Glossy paint (computer-grey or something) for the generator's outside
- Silk matt black paint for the generator's interior
- A small (low-wattage) lamp, preferably colored light (optional)
- Silicone chalk (preferably black)

## 4.2 Tools

You will need the following tools for assembly:

- Heat gun
- Hot glue gun with glue
- Machine saw or hand saw for cutting the plywood/plexiglass disks
- Small drilling tool with set of drills
- Sharp knife to cut the PVC sheeting
- Screwdriver
- Sandpaper or sanding machine
- Riveting tool
- 30mm round mould (empty paint can or something)
- 75mm round mould
- 100mm round mould
- long ruler or straight bar, length  $> 1200\text{mm}$

## 4.3 Description of materials

- *plywood or MDF disks* comprise the top and bottom of the generator box. I recommend using MDF for these, since this type of wood is easy to work with and has very smooth surfaces. Also, plywood tends to warp and is harder to get waterproof by painting.
- *plexiglass disks* for top and bottom of generator interior. Do not yet cut these out of the plexiglass sheet, the disks have to be deformed with a heat gun and this is hard to do when the disks are cut to size first (moreover, the disks will warp, then - which is very hard to fix).
- *wooden support blocks* to mount the plexiglass disks on the wooden disks. The blocks all have to be of exactly the same length, other dimensions don't matter that much, since these blocks won't be visible when the project is finished.
- *PVC sheet* comprises the outer surface of the generator. Use a strong material for this sheet, it has to support big part of the generator's weight. I used PVC sheet which did the job very well. Don't try to use plexiglass by curving it around the disks... it will almost certainly crack, and if it doesn't, it will stay under high tension (likely resulting in breakdown of the generator at some later time).

- *(radial) blower fan* - choose a radial-type of fan, these have a useable air entrance / exit. The standard cooling fans (like those used in computer power supplies) are by far too weak to power this generator. A radial blower has 1 air entrance (suction) and 1 air exit (blowing). This type of fan can be easily positioned in the generator's fan compartment and connected without too much work involved in fabricating airflow tubing. (actually I dimensioned the generator just to fit a radial blower fan). The fan has to have a capacity comparable to that of a common household vacuum cleaner. Try to locate a fan which powers on standard line voltage (you won't need a separate power supply, then). Also, select one which operates as silently as possible. In fact, if you can't find any suitable fan easily, salvage one from an old vacuum cleaner. This may be the cheapest solution, as you won't need an extra power supply.
- *power supply* - if the fan you use must be powered with other voltage than the standard 230 VAC (115 VAC in the U.S.) line output voltage. The fan I used runs on 12V DC @ 3.5 amp (max), so I had to use a 12V DC @ 4 amp power supply.
- *RPM driver* to adjust the RPM (rounds per minute) of the fan, to form the different sorts of tornados (weak to strong). Try to obtain an adjustable power supply, this eliminates the need of a separate RPM driver. RPM drivers are sold as kits to be built by yourself, or as already built-up units. Cost: about \$10 - \$15. If your fan runs on line output voltage 230 VAC (115 VAC in the U.S.), use as RPM driver a Variac(TM) (variable output transformer).
- *mist generator* to make the tornado vortex visible. I designed the tornado generator for a special type of mist generator, about 40mm in diameter, 30mm tall. I got this from an electronics mailservice (Conrad Electronics, they carry/carried it at stock nr. 570990 - no product endorsement, they are for sale elsewhere). The mist generator is a micro-sized ultrasonic humidifier for artistic purposes, .... "for making your own attractive humidifier" (well, I am sure I did!). Common ultrasonic humidifiers will do perfectly, too, but these are usually quite bulky machines which won't fit in my generator design. However I recommend you to adjust the generator dimensions for your project, if you happen to have such an ultrasonic humidifier. I'll note this dimensional adjusting later on in this document. Be sure to what type of mist generator you'll use before you make the generator to size, else you may end up with a generator too small for an ultrasonic humidifier to fit into, and a lot of extra work may be involved to make it fit. I believe the mini-sized mist generator type I used may also be available at drugstores, warehouses or electronics shops.
- *PVC tube* for blowing the air entering at the front of the generator sideways, to let it start rotating. I used the sewer pipe type of PVC pipe, 32mm in diameter.
- *screws (and washers)* for mounting the support blocks on the wooden disks and mounting the plexiglass disks, and for mounting the PVC sheet (mantle of cylinder) and aluminum strips on the wooden disks. Screws have to be about 3mm - 4mm thick, bold-headed, 30mm - 40mm in length.
- *rivets* for securing the aluminum strips to the PVC sheeting. This can also be done with some glue but the strips tend to get loose by themselves when using glue, so I riveted the



strips and sheet together. You can also use some paper clips but rivets will look more professional on the device. (Some small bolts with nuts and washers will do perfectly, too).

- *aluminum strips* To strengthen the edges of the PVC sheeting (to prevent warping due to the weight of the generator). The strips will run full length along the generator.
- *glossy paint* to give the generator a nice finishing touch - the PVC sheet is clear and will show wooden blocks and disks - really looks ugly without some paint.
- *silk matt black paint* to paint the interior of the generator black. This enhances the contrast of the tornado vortex with the background. Don't use glossy paint for this, it will reflect too much light. Matt black paint can do too but this tends to get dusty and grey in time, due to the rough matt paint surface. Silk matt paint yields best results.
- *small lamp* this will be positioned in the fan compartment (region between upper wooden disk and upper plexiglass disk). It will light the tornado vortex from behind, making it extra visible. Colored light is really great for this purpose!

## 5 Metric system conversion factors

The dimensions of my design are in mm (millimeter, 1/1000 of a meter). If you're more at home in inches and feet, here's the conversion to from the metric system. For convenience I put both-way conversions in here):

$$1 \text{ mm} = 0.0394 \text{ in (thus nearly } 1/25 \text{ in)} \quad 1 \text{ in} = 25.4 \text{ mm}$$

$$1 \text{ m} = 39.4 \text{ in} \quad 1 \text{ in} = 0.0254 \text{ m}$$

$$1 \text{ m} = 3.28 \text{ ft} \quad 1 \text{ ft} = 0.3048 \text{ m}$$

$$1 \text{ mm} = 0.00328 \text{ ft} \quad 1 \text{ ft} = 304.8 \text{ mm}$$

$$1 \text{ liter} = 0.22 \text{ gallon} \quad 1 \text{ gallon} = 4.5 \text{ liters}$$

So, for example, the tornado generator will be 1200mm tall, this is  $1200 \times 0.0394\text{in} = 47.24\text{in}$  or  $1200 \times 0.00328\text{ft} = 3.94 \text{ ft.}$ , etc.

## 6 Construction

A schematic exploded view of the generator is displayed in figure 1.

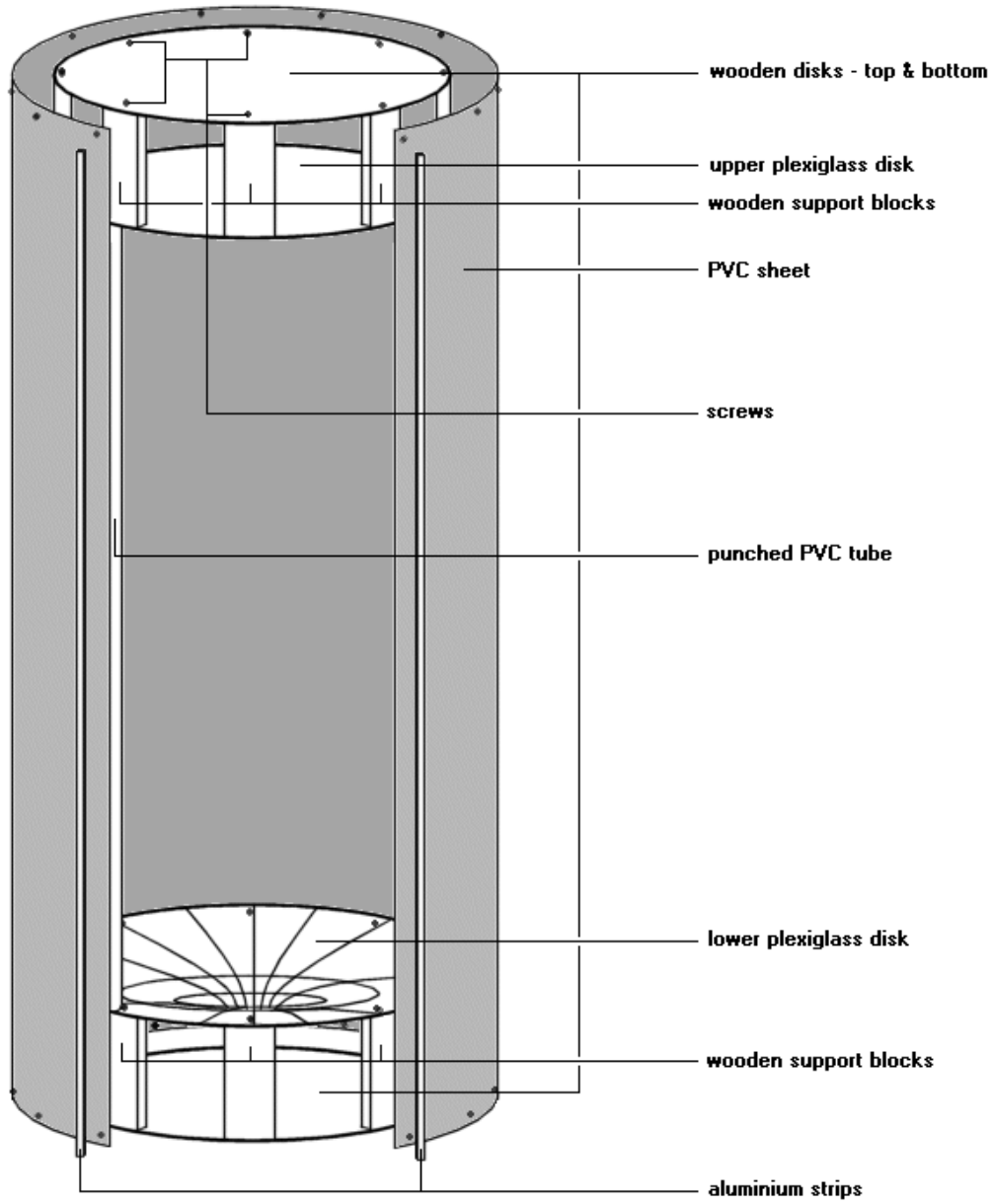

Figure 1: Exploded view of generator construction.

## 6.1 Cutting the wooden disks and support blocks

Cutting the wooden disks and support blocks First, draw two 400mm diameter circles on the wood using a pair of compasses and cut out the two wooden disks. Make sure the disks are perfectly round, for every inconsistency will show on the finished generator. Out of one disk, cut a smaller disk, 300mm in diameter (this will be some sort of hatch to access the fan compartment later on). Sand the three pieces and lay them aside. Save the plate of wood the disks are cut out of, you will use the circular gaps as a matrix to deform the plexiglass disks.

Next, cut the 16 wooden blocks to length and sand them. Verify that all are of the same length. Variations of at most 1mm are acceptable.

## 6.2 Making the lower plexiglass disk

*TIP: if you're in a hurry (who's not in a hurry to see the generator working, anyway??), forget about the heating and deformation of the plexiglass disks and use flat ones. The curved lower disk is to let water flow back to the center water pool, while the upper plexiglass disk is only curved for stability. The tornado will not be influenced much when using flat disks.*

Now take the sheet of plexiglass where the disks will be cut from. Lay the sheet on top of the plate of wood where the wooden disks were cut from, and position the part (of the plexiglass) which you want to cut a disk from on top of the gap in the wooden plate. Clamp the two sheets together using glue clamps or something. Be careful with clamping, the plexiglass may crack easily, especially this 2mm thin sheet. Support the two sheets at the underside with some scrap material or books to lift the sheets about 20cm (8") above the working area.

With a permanent marker, draw a circle 400mm in diameter on the underside of the plexiglass sheet (that is, use the wood as a stencil). Next, with the plexiglass sheet on top, use a ruler to locate the center of the disk and dash it. Rotate the ruler 90 degrees and repeat, you now have a cross which is at the center.

Locate the 75mm round mould (I used an empty paint can 75mm in diameter), and fire the air heating gun. Set it on most powerful setting (mine was able to set a piece of wood on fire at close distance). Now heat the plexiglass sheet over the matrix, going around with the heat gun starting at the edge of the disk and spiralling towards the center and back, and repeat some times. Make sure you heat the center part more than the outer edge of the disk, and make sure there occur no "hot spots". So heat the plexiglass evenly, but more and more towards the center. Take care you don't heat it too much to let it form bubbles - some bubbles are okay but it needn't get any hotter.

Turn off the gun, and take the 75mm mould. Use the center cross mark to position the mould over the center of the disk, set it on the plexiglass surface and press. Press it about 100mm - 120mm down or so, if you heated the plexiglass right you will see the shape in figure 2 forming. Make sure you're holding the mould horizontally positioned, so the 75mm bottom is parallel to the sheet. Hold it in place for about 1 or 2 minutes to let the plexiglass harden. If you're not

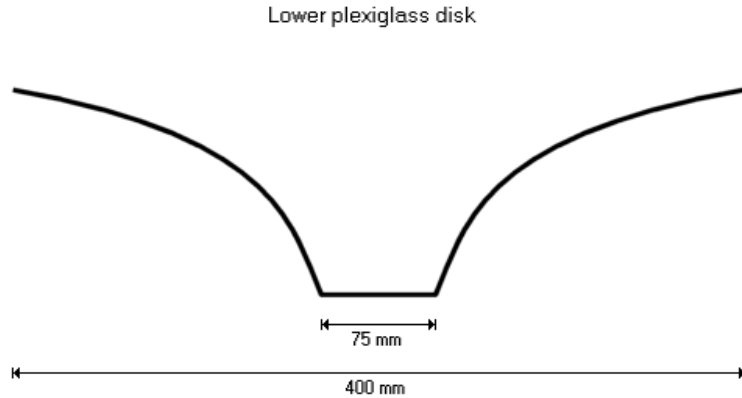

Figure 2: Approximate cross-sectional shape of lower plexiglass disk. The curvature serves both to create a water basin for the mist machine, as well as allowing the water to flow back to the basin.

able to press the mould in the plexiglass deep enough, reheat the plexiglass until it does. Make sure no holes form in the plexiglass (this will become the lower plexiglass disk which will be filled with water during generator operation).

Remove clamps and cut out the deformed disk using the drawn circle as a guideline. Take care you do the cutting slowly... the plexiglass will crack easily, maybe spoiling all the work. Saw the plexiglass with speed of 3 to 4 mm/s at most. Also, take care not to saw too slow, because the plexiglass will run hot by the saw, and may stick to the blade, resulting in a mess (and a jammed saw blade).

When done, sand the shaped disk and put it in a safe place.

### 6.3 Making the upper plexiglass disk

For the upper disk, proceed in the same way. But now after heating use the 100mm mould, and press it for only 50mm deep in the plexiglass. After it has hardened, remove the clamps, turn the plexiglass sheet over, and reheat the center part (in the 100mm area). Heat this part as hot as possible. Then take the 30mm mould and press it 70 - 90mm down, to obtain the shape as in figure 3. You may have to repeat the last step (heating and pressing), for this is a difficult shape. This time it's no big problem if any holes form in the plexiglass, you can put some tape over it if necessary. The upper disk needn't be water tight. It's also not bad if the shape is not exactly the same as in figure 3.

When done, cut the disk out and sand it. Take a 6mm drill and drill a hole through the center cross marking (drill slowly else the plexiglass will crack - due to heating and deforming the glass may be as thin as 0.5 mm in this area). Next get the file and carefully file the drilling hole to 30mm size as in figure 3. Make sure the hole will be round and not much smaller or larger than

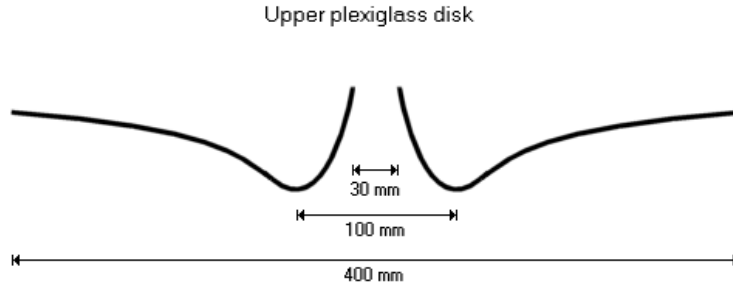

Figure 3: Approximate cross-sectional view of upper plexiglas disk. The shape helps create downward-moving wave-instabilities in the vortex due to the slow-moving convergent air along the plexiglass surface (friction), which make the vortex more visually attractive. It also serves to hide the central hole.

30mm. And take your time when drilling and filing, if things go wrong you'll spend a lot more time making a new disk!

Finally mark and cut the hole for the PVC air blowing tube in the disk as shown in figure 4. Dimensions of this hole are the diameter of the air blower tube you use plus 1mm width, and diameter plus 3mm in length. This extra mm are for installing the tube when the generator is ready (the tube can't be put through the hole straight, and may have to be removed and reinstalled later on), and for connecting the tube to the fan later on. If your PVC tube is not 32mm in diameter make the hole to fit that tube. Note: cutting out this hole can best be done

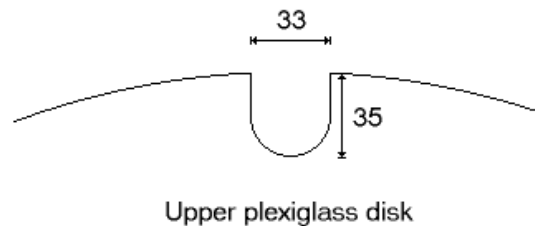

Figure 4: Cut-out hole in the upper plexiglass disk, to allow the PVC tube to run through.

with a file, it will take some time to carefully file the hole out but else the plexiglass could also crack. If it happens to crack, use instant glue to correct the problem.

Now try to be neat and clean the filings and saw dust out of your working area. Especially the plexiglass filings and sawing rubble are sharp and bad for your health. (I got such a plexiglass filing in my eye when cutting the disks, this caused a lot of pain. Make sure you wear glasses or something when sawing plexiglass!)

## 6.4 Cutting the PVC sheeting

The PVC sheet is usually sold as a sheet to cut from a roll (I got mine from a DIY shop). The roll will be about 1 meter wide, this is just enough for the partial circumference of the generator. The generator's slot must be about  $1/5$  of total circumference, so for a generator 400mm in diameter the circumference is 1257mm, and the part to be covered with sheet is about  $4/5 \times 1257\text{mm} = 1005\text{mm}$ . That leaves a nice opening of 250mm. It doesn't matter much what size the gap will be, as long as it doesn't get anywhere near or bigger than  $1/4$  circumference (in which case a tornado, if it ever forms, might be very unstable).

Uncurl and lay down the PVC sheet on a flat surface (choose a surface which may get cut marks on it). Now with a permanent marker (overhead sheet pen or the like) draw a  $1200\text{mm} \times 1000\text{mm}$  rectangle on it, making sure it has straight corners. Then use the long ruler or (metal) bar to cut the sheet to size. Take care the knife doesn't slip, or that the ruler doesn't slip and rotate. One cut is enough, it needn't go all way through the PVC, you can bend the sheet to make it crack neatly along the cut. When loose, sand the cut edges of the sheet and lay it aside.

Next cut the two pieces for above and below the generator opening, and sand them. Size: upper sheet  $300\text{mm} \times 175\text{mm}$ ; lower sheet  $300\text{mm} \times 250\text{mm}$ .

## 6.5 Making the upper and lower compartments

Locate the two wooden disks, the wooden ring, the two plexiglass disks and the 16 wooden support blocks. Drill holes that fit the screws at the edges of the plexiglass disks and wooden disk and ring, as in figures 5a and 5b. If the support blocks are 18mm thick (mine were), drill the holes 9mm off the edges of the disks.

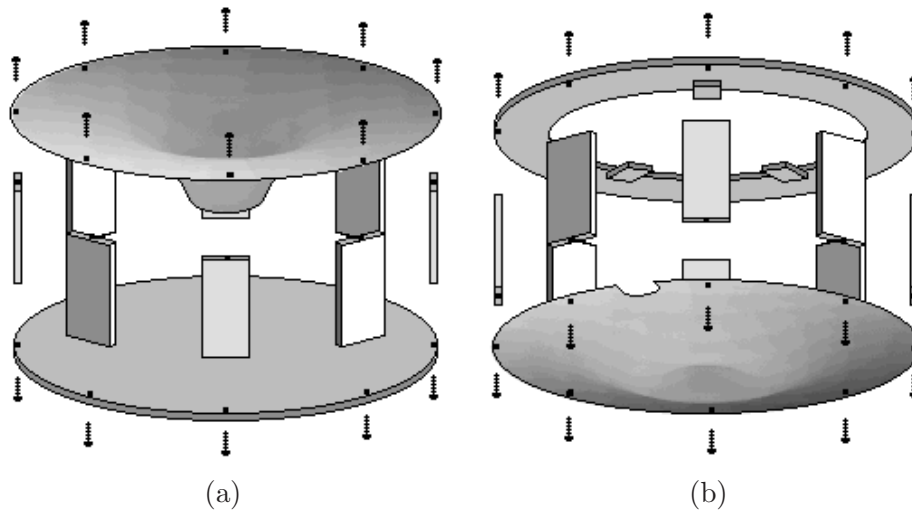

Figure 5: Exploded view of lower compartment (a) and upper compartment (b).

From scrap material, cut three small wooden blocks and mount these partly over the inner edge of the wooden ring, to act as locks for the inner disk (hatch) to be supported (visible in figure 5a). Don't forget this step (like I did), for it's almost impossible to mount the scrap blocks on the ring if the generator is finished (using screws, that is).

Using the screws, assemble the upper and lower compartments as shown in figures 5a and 5b. Take care you use the upper plexiglass disk in combination with the wooden ring (else you'd end up with a hatch in the bottom of the generator). Also take into account the proper orientation of the plexiglass disks, refer to figures 6a and 6b for cross-sectional views of the compartments.

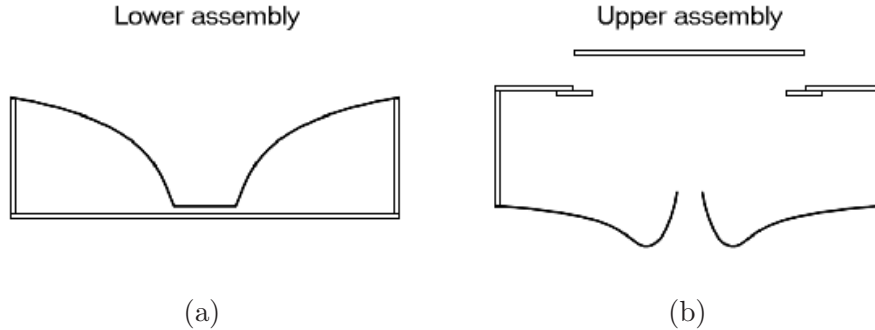

Figure 6: Cross-sectional view of lower assembly (a) and upper assembly (b).

Tip: it's best to pre-drill holes in the support blocks, too, else the blocks risk getting split when screwing in the screws. For this drilling use a drill about 0.5mm or 1mm smaller than the screws. When assembling the compartments, take care no blocks protrude at the edges of the wooden disks and plexiglass disks.

Note: Don't forget to use the washers with the screws, else the plexiglass disks may crack (I think, tonight, you'll dream about that warning... *The plexiglass may crack* :)

## 6.6 Preparing the PVC tube

From PVC tubing, cut a tube 1000mm long, and sand the ends. Next, mark a line all along the tube, and mark drill locations every 25mm along this line, as in figure 7. Leave 150mm on one end clear (this will be the upper part of the tube in the generator).

Next, use a sharp tool to punch the mark locations a bit (this is to prevent drill swerving when drilling the holes). Next take a 6mm drill and drill the holes. Take extra care you drill all holes straight, all holes must be essentially parallel to each other and straight to the tube. I state "essentially" here, because the appearance of the tornado vortex depends on the hole orientations. If one hole is drilled slightly tilted to the other holes, the air exits this hole in the same "invalid" direction and the air rotation in the generator will not be exactly cylindrical, thus the tornado will not be at the center but curved slightly to one side. Note this effect at the photos on this page - these are photos of my generator. I drilled the holes not exactly straight to each other,



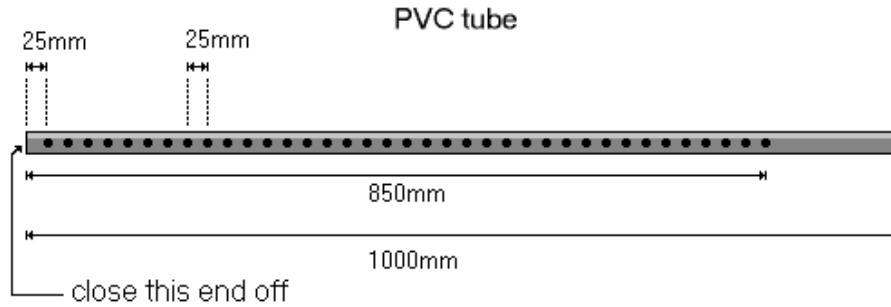

Figure 7: Appearance of the PVC tube with air holes.

and thus the tornado vortex is curved a little bit. I like the effect, so I didn't care about making another PVC tube with straight air exit holes.

So drill the holes essentially straight (straight for the eye). Then your tornado vortex will not be perfectly straight, but curved and a little eccentric (about 5cm, 2") to the generator's center. But if you prefer a perfectly concentric tornado vortex, by all means use a drill stand.

Note: this curved vortices story only applies to the case that the generator's fan is running low-speed. In that case the tornado vortex is most sensitive for disturbances (like a tilted air exit hole at the tube). If the fan is running full-power, the tornado will be at the center, for then all air is rotating very fast, thus cylindrically.

After drilling, clean the inside of the tube, there will be a lot of drilling scrap in there which you must get rid of. Then sand the surface of the tube to remove the rough rims of the drilling holes, and to obtain a good painting surface.

Now close the lower end of the tube off (you can use hot glue for this, in combination with some small scrap wood). The lower end of the tube is the end with the drill holes, the left end in figure 7.

When done, paint the tube black, using the silk matt paint for the generator's interior. Don't use too much paint, else it will flow in the air exit holes too much. You'll need two coats, at least, to paint the tube.

## 6.7 Assembly

Now is the time to assemble the generator. Lay down the large PVC sheet, and place the lower compartment on its edge at the edge of the PVC sheet. Curl one end of the PVC sheet around the round compartment assembly, align the outer edge of the sheet with the undersurface of the wooden disk of the compartment, as in figure 8. Screw at the marked locations 1 and 2 two screws through the sheet, in the edge of the wooden disk. Screw 1 must be about 50mm from the end of the sheet, for the smaller sheet to fit in later on. Take care when screwing in the

two screws, that the edge of the sheet remains aligned with the disk undersurface. Also note the proper orientation of the pvc sheet, roll the compartment assembly along the shorter edge of the sheet (1000mm). This way the sheet won't run all way round the compartment assembly, thus in the right way to leave open the generator front opening.

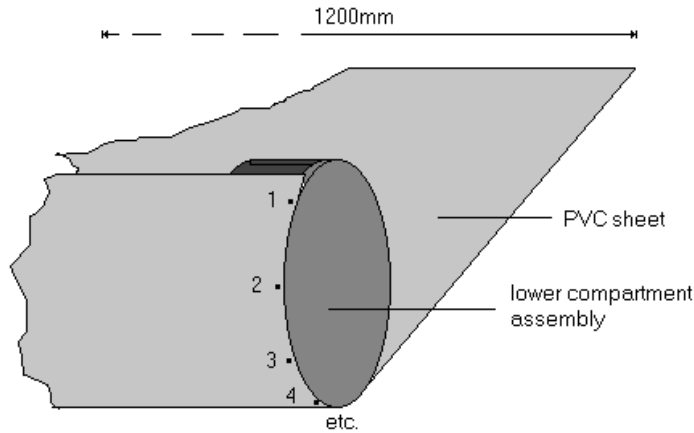

Figure 8: Attaching the sheet.

Don't screw in the other screws - yet, just the screws 1 and 2. Now roll the sheet around the compartment and temporarily put tape all around so the sheet doesn't unroll. Next, take the upper compartment assembly, and put it in place. Rotate the thing so that the hole in the upper disk (for the air blower tube) is about 100mm at the left of the left edge of the front opening, as in figure 9.

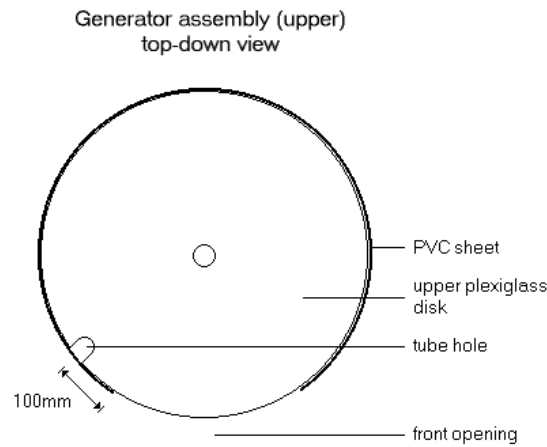

Figure 9: Location of the tube hole with respect to front opening.

Next, fasten the upper compartment assembly with two screws at the same positions as at the lower compartment assembly, and tape around again, you now have something like in figure 10.

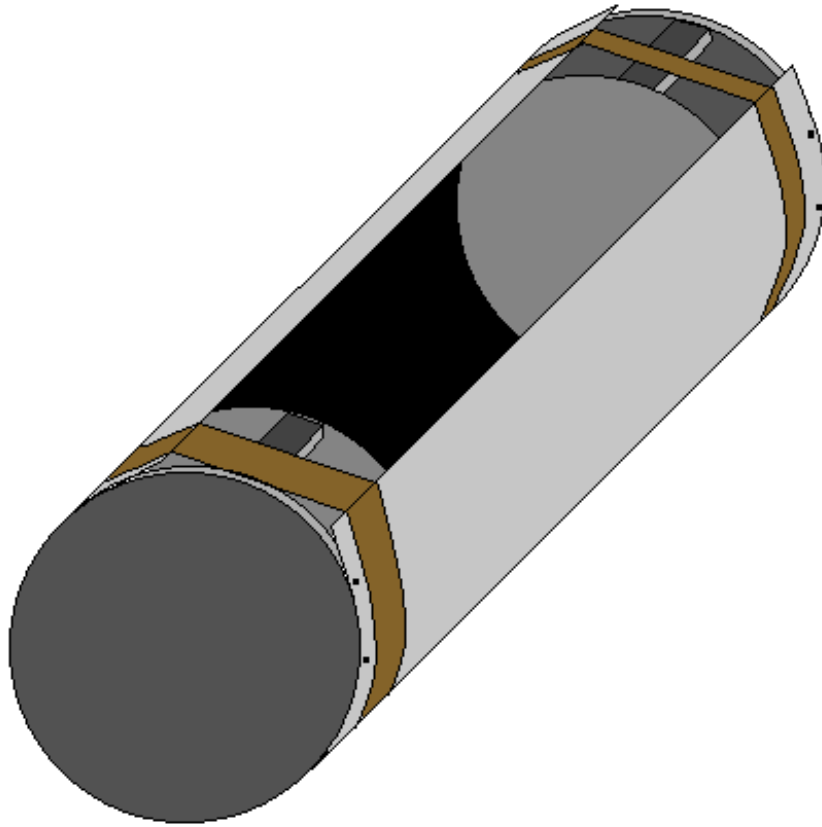

Figure 10: Fixing the sheet and taping to hold it in place.

Now you can fasten all other screws around the edges of the sheet, and when done remove the tape. Make sure the edges stay lined up exactly along the surfaces of the wooden disks, and don't screw down the ends of the sheet at the opening, yet.

Next take the two smaller PVC sheets, and insert these under the edge of the large sheet over the gap still at the compartments (above and below the generator's front opening). Use the smaller sheet for the upper part (sheet 300mm  $\times$  175mm). See figure 11. Still do not screw down the corners of the large sheet. Fasten the small sheet with two screws 1 and 2 in the wooden disks, as shown in figure 11.

Proceed in the same way with the lower sheet (300mm  $\times$  250mm).

You'll end up with something looking like figure 12.

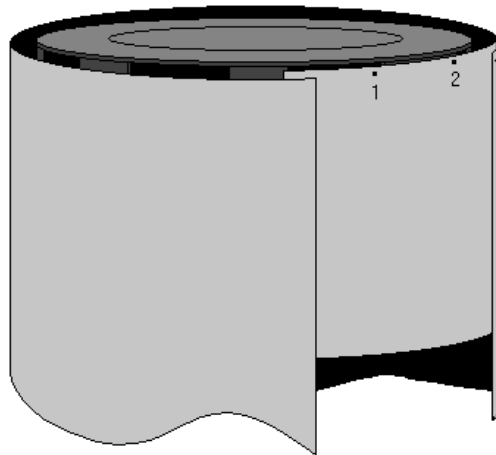

Figure 11: Sheet layering assembly above the front opening.

## 6.8 Painting

Before attaching the aluminum strips (and screwing down the corners of the PVC sheet), paint the generator body. You can paint the whole thing in one time, except for the under surface where the generator stands on. Before painting, slightly sand the PVC surface to make it rough and to remove any dirt. Also sand the inner surface (inside the generator), and the plexiglass disks.

Paint the inside of the generator using the silk matt black paint. You don't need to paint the interior of the compartments, these will not be visible when the generator is finished. So paint the inner surface of the PVC sheet and the two plexiglass disks. For the upper plexiglass disk, leave a sector on the disk, at the rear of the generator, free of paint, this will be necessary for the light which will be installed in the upper compartment. I used a painting scheme for the upper plexiglass disk as in figure 13.

Tip: start painting the upper plexiglass disk, next the remainder of the interior and last the exterior.

Paint the outside of the generator in the color you like. I used computer-grey paint. Note: The PVC sheet is hard to paint in one time, it's best to use little paint (to prevent sagging), using a soft brush.

When the paint has dried, slightly sand the painted surfaces, and repaint it. After this second coat has dried, inspect to decide whether it needs painting a third time. I didn't need to paint the generator for a third time, however.

If you want to, you can paint the bottom of the generator, too. I was impatient to see the generator finished and operating, so I didn't paint the bottom wooden disk.

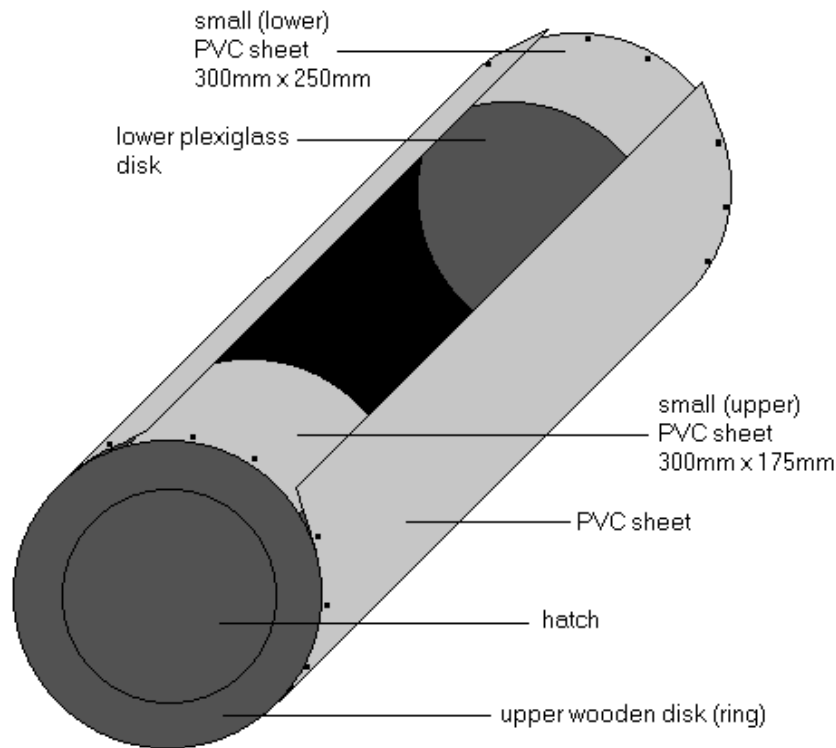

Figure 12: Finishing attachment of the sheet.

## 6.9 Attaching the aluminum strips

Wait 48 hours to let the paint harden out, then take the two aluminum strips 1200mm in length, and drill holes, to fit the bold-headed screws, at the ends of both, 9mm from the ends. Next drill 4 more holes in each strip, to fit the rivets, at 165mm, 430mm, 695mm and 960mm. When done, take 2 screws, and screw down the ends of the large PVC sheet (at the top of the generator), together with the small sheets, with the aluminum strips on top, at the two marks 'A' on the left in figure 14.

Next use the 8 rivets and rivet the PVC sheet(s) and the strips together at the 'B' marks in figure 14, working your way down the generator (to eliminate warping of the sheet). Finally screw the other 2 screws in at the 'A' marks at the right in figure 14.

When riveting take care that the sheet stays in position, it may help to temporarily tape down the sheet at the bottom of the generator while riveting the strips on the sheet. Also be careful you don't bend the strips, this will greatly reduce their strength.

Light window (sector free of paint)

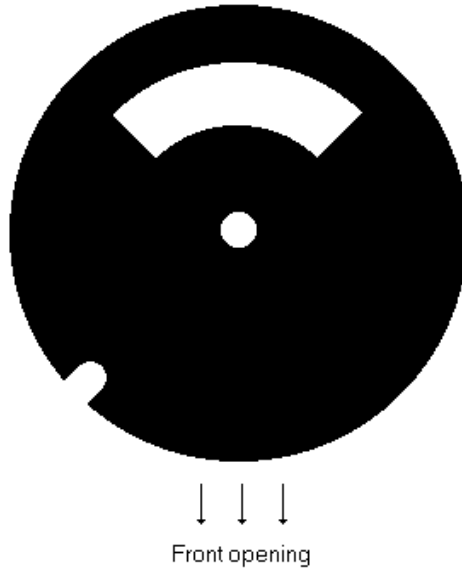

Figure 13: Top view of plexiglass disk. Paint layer should be on other side.

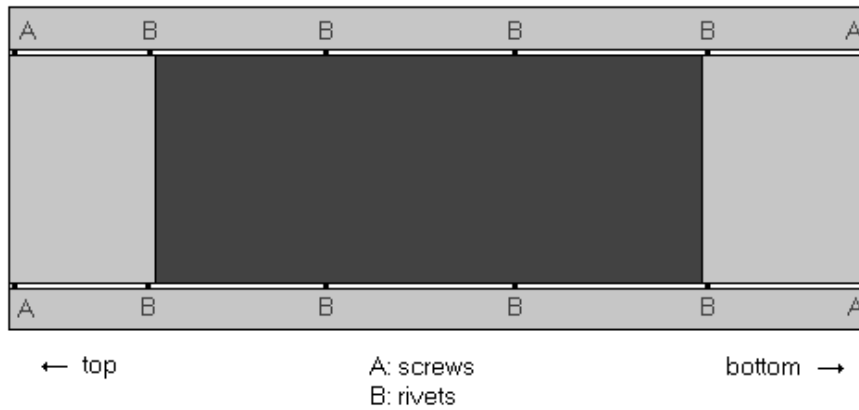

Figure 14: Attaching the aluminum strips.

Tip: lay down the generator on its side when fastening the strips, in that position there will be minimal stress to the edges of the PVC sheet.

Other tip: use relatively small rivets and drill holes in the strips, else the strips may bend or even crack at the drill holes.

## 7 Miscellaneous installation

### 7.1 Installing the fan and airflow channels

I assume you have a radial blower fan like the one in figure 15, with axial (central) air intake and radial air exit. This type of fan is easiest to install in the generator, and has a strong blowing capability versus suction, which is essential to this design.

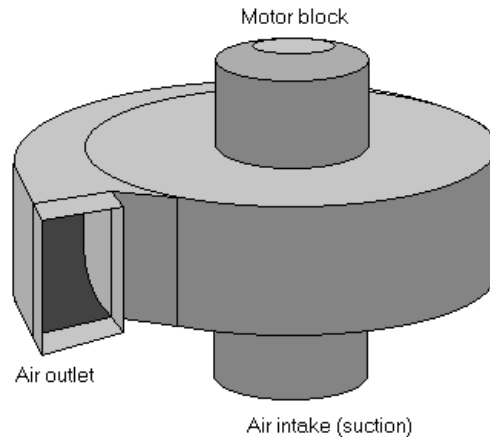

Figure 15: Schematic drawing of a radial-type fan.

Now check the height of the fan, it might not fit in the generator's upper compartment, like mine didn't. My fan had a motor block protruding at the top, so I had to drill a large hole in the hatch for the fan's motor block to stick through. Other radial fans I have seen don't have such a motor block, these should fit in the compartment right away.

Install the PVC tube in the generator, with closed-off end pointed downwards. Don't use any force, the tube will fit easily, if it is put in the generator first, and then stuck through the tube hole at the edge of the upper plexiglass disk. When done, set it vertically, there now is about 50mm of tube sticking out in the fan compartment.

Temporarily install the fan with air intake downwards on the upper surface of the upper plexiglass disk, the air intake will more or less fit around the hole in the disk, as in figure 16. Now I'll describe the easiest way to make an airflow channel:

Take an old sock of yours (not *that* old - it must not have any holes in it), cut off the toes-end to end up with the airflow channel (that's it). Connect one end of the sock to the air outlet of the fan, put some tape, rope or fishline around it to secure it to the fan exit, and reinstall the fan. Now put tape around the air intake where it touches the plexiglass disk. If necessary hold the fan in place with some scrap wood or something.

Finally connect the other end of the sock to the end of the PVC tube, and put tape around (this is hard to do, however, because the tube nearly touches the PVC sheet of the generator - I used some fishline to connect the sock). Make sure the sock isn't twist, this will prevent air flowing through the sock to the pvc tube and no tornado may form.

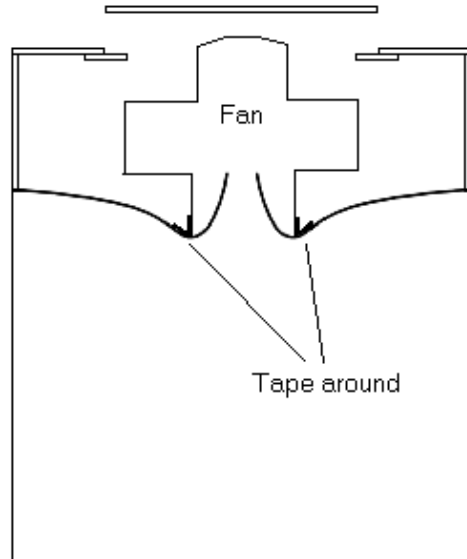

Figure 16: Installation of the fan into the compartment.

If you're ambitious, by all means use genuine tubing to fabricate the airflow channel, like that of a vacuum cleaner. For my generator, an old sock was best, because a sock isn't air-tight. This is advantageous, because the fan needs to release (compressed) air. If it can't, it won't suck any more air, either, and the fan will go run like hell, doing no work at all. It's okay to experiment with airflow channels, when you get the generator working. But start out with the old sock method, this works well in any case.

Finally lead the electrical wires out of the compartment, so you can connect the power supply (if applicable to your fan) easily. Then close off the upper compartment with the hatch.

## 7.2 Installing the mist generator

There is much to say about this. The mist generator I used is very small, and will be placed at the bottom center of the tornado chamber, thus on the lower plexiglass disk. Lead the power connector wire out of the generator via the back side or something, so it isn't that much visible, and tape down the wire to the plexiglass and/or PVC sheet, so it won't disrupt the airflow too much. Next, use some hot glue to fasten the mist generator to the plexiglass, else it may fall



over. Then fill the plexiglass disk with clean water (distilled water is best for the mist generator), until the water is about 30-40mm over the ultrasonic mist generator.

Note: this is only applicable to the mist generator I used!! Other ultrasonic humidifiers will do perfectly, too, but these aren't operated under water, like mine! You may have to modify the lower plexiglass disk, by drilling a hole in it, for instance, to put through the mist exit nipple of the humidifier, if the humidifier you use is a larger machine and you need to install it in the lower compartment. In any case, make sure the mist produced by the generator will indeed enter the generator's mid section, where the tornado will form, and preferably enters it on the bottom (thus at the plexiglass disk) at the center (then the inner structure of the tornado will be best visible, else mist at the outer edge of the generator will obscure the tornado vortex).

The correct installation I have drawn in figure 17a, for if you use the same sort of mist generator I used, and in figure 17b for a 'genuine' ultrasonic humidifier, with different generator dimensions (see below: dimensional modification). Note, in this case you might want to have a differently shaped plexiglass disk, to fit the mist generator in the lower compartment. If your mist generator is taller than 130mm you'll need to have a larger compartment! Or if you already made the tornado generator at given dimensions, you'll have to use the mist generator outside the tornado generator, and connect to it using a small tube. However, I'm not sure whether the mist will be dense enough, then, so keep connection as short as possible.

### 7.3 Installing the light

For the light, use a low wattage lamp! For instance, a 5 Watt bulb or something. Install this in the upper (fan) compartment, over the window in the plexiglass disk. You can make a switch in the PVC sheet to easily switch the light on and off.

When using a too high wattage light, the lamp will heat the plexiglass disk and may deform it. Also, the PVC sheet is not even heat resistant and will immediately deform, which is hard/impossible to fix neatly (I had that problem, and ended up with a bumpy patch of sheeting at the side of the generator).

When using not any lighting at all, the upper part of the tornado will be poorly visible, because the upper front of the generator will cast its shadow on the misty vortex. The light is to lighten up the tornado from the top. However, I didn't bother yet to install any lighting in my generator. A floor lamp or something put in front of the generator chamber will light up the vortex nicely, too.

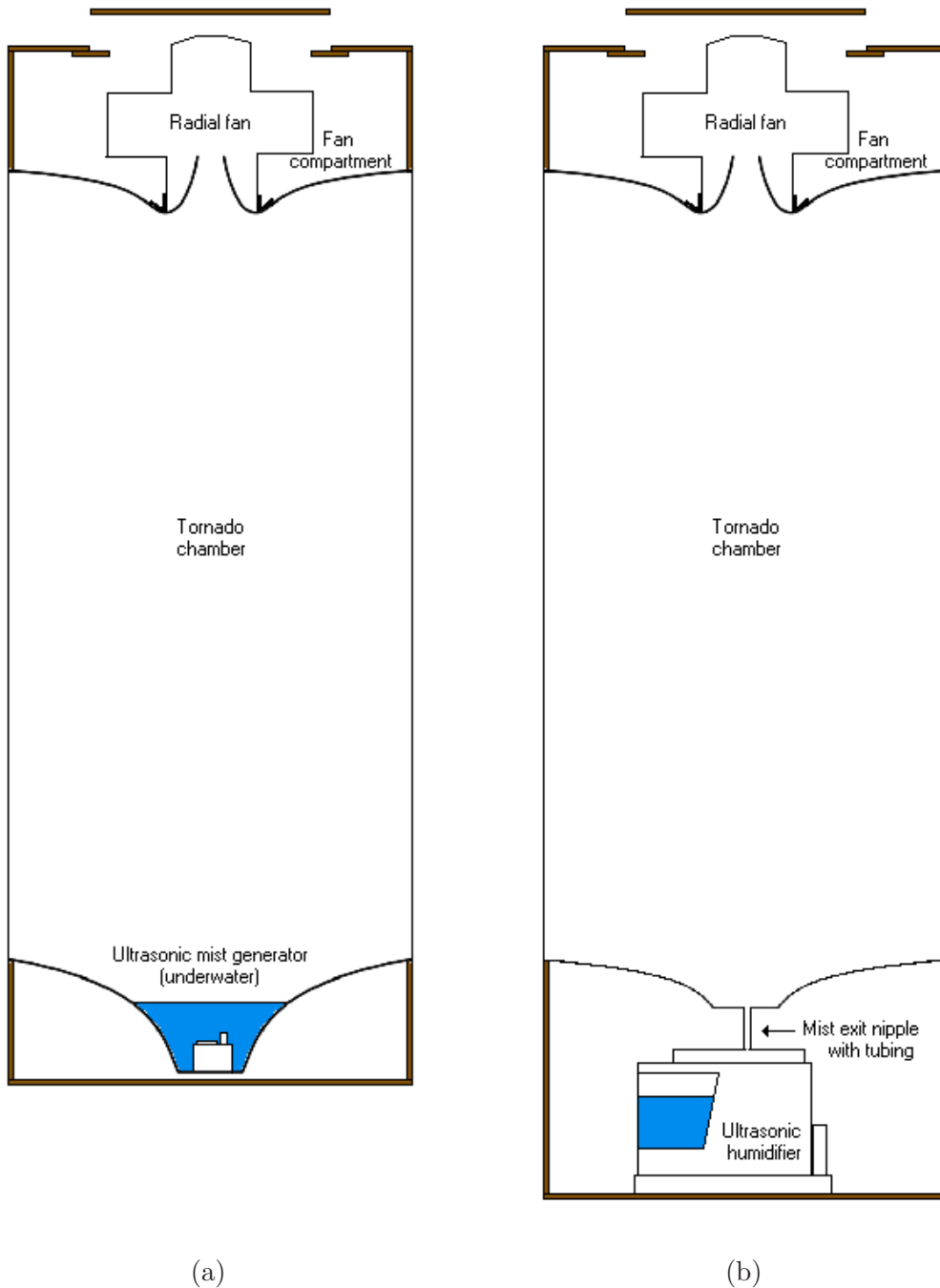

Figure 17: Cross-sectional view of generator using artistic mist machine (a) or if using common, bigger ultrasonic humidifier (b).

## 8 Finishing touches

Rotate the PVC tube so that the air exit holes point to the generator's front opening, as in figure 18, and hot-glue the tube in straight upward position to the lower plexiglass disk, so it won't

rotate by itself or slip.

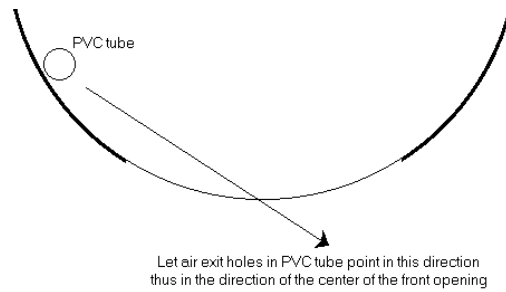

Figure 18: Proper direction for the air holes with respect to generator front opening.

Next, kit the edges of both plexiglass disks, where they touch the PVC sheeting, with (preferably black) silicone caulk, to make these locations water tight. Also, kit around the PVC tube where it touches the upper plexiglass disk.

Let the caulk harden out, this may take some time. After it has set, check the fan compartment to see whether the sock has twisted (because of rotating the PVC tube), if it has, untwist the sock.

Cross sectional views of the generator are in figures 17a and 17b.

## 9 Dimensional modification

This is about adjusting the size of the generator, with the purpose of letting your mist generator fit into the lower compartment. If you want to use a large ultrasonic humidifier, it is best to install it in the lower compartment (I'll call this the mist compartment from now on). If it won't fit in this design, or you want to be sure, then adapt to these modifications:

- Make the large PVC sheet 1000mm  $\times$  1400mm;
- Make the lower small PVC sheet 300mm  $\times$  450mm;
- Make 6 of 14 wooden support blocks 350mm in length (for mist compartment), the other 8 still 150mm (for fan compartment);
- Use aluminum strips 1400mm in length, preferably with larger cross-section 3mm  $\times$  12mm or something (due to their length);
- Use a different shape for the lower plexiglass disk, by pressing the mould for only about 50mm instead of the 120-130mm. (it has still to be curved, to let water droplets which form during operation, and precipitate down, flow to the center (so the generator doesn't get soaked).

That's it, now you'll end up with a 1.4 meter tall generator with a mist compartment over 300mm in height, which will fit most common ultrasonic humidifiers. One note about the wooden support blocks: omit the 2 support blocks (that's why you need only 6) on the back side of the mist compartment assembly, and after the painting stage, cut a hole in the PVC sheet over the missing supports, to gain access to the mist compartment at the back of the generator, so you can install the humidifier (the access gap must not be visible at the front side, this really looks ugly!).

## 10 Running the generator

Now you can test run the generator. Connect the fan to the RPM driver, and this driver to the power supply (or connect the fan to the Variac(TM) and this to a wall outlet, in case your fan runs on standard line output). Next, pour water in the lower plexiglass disk, if you use the same mist generator as mine, or fill up the humidifier or whatever. Turn the mist generator on, and if some mist has accumulated at the bottom of the tornado chamber, run the fan. You should now see the mist start rotating around, and after 5 - 10 seconds to 1 minute (depending on fan speed), you'll see the tornado develop upwards to the fan suction.

Have fun!

### 10.1 Operation tips

Some fascinating things to do with the generator:

- Run the fan *\*very slowly\**, then there will be a cloud of mist slowly rotating at the bottom center of the generator, out of which a tornado will form only after about 2 minutes. This tornado is very thin, like a rope, and stationary positioned in the chamber, curling its way to the top of the chamber. After a while, turn off the mist generator, and wait until all mist has been sucked up in the tornado. This can take as long as 5 minutes! The tornado will eventually become transparent, and you can watch the different layers of rotating fog near the core of the vortex.
- Run the fan full speed, and switch the humidifier on, off, on,... etc. If the mist "pulses" of the humidifier are entering in the core of the tornado, you will see the mist puffs raging their way up through the core with speeds exceeding 5 m/s! Clearly, the air pressure is indeed low at the core, for this mist to advance so quickly through it. If the mist is not entering exactly in the core, it will speed upwards but not that fast, or may stop and start rotating around the vortex.
- Run fan full speed, power off the humidifier, and wait a while for the mist to disappear in the tornado. When nearly all mist is gone, you'll still see a very thin layer of fog, over 100mm in diameter, around the tornado core (which itself not visible anymore). The fog layer will swing and every now and then show wave-like patterns seemingly going downwards.
- Disrupt the tornado by putting your hands in the vortex, and watch it recover. If the fan is running very low speed, the tornado has much difficulty in restabilizing itself.
- Run fan full speed, and if a strong tornado has developed, put your head in the chamber to look down (or up) through the tornado's core. This is really cool! But do that quickly for the tornado will breakdown the moment you put your head in the tornado, so you don't have much time to look through the core. If the tornado is not curved, you may even see the mist output at the bottom of the generator, by looking through the core. Note: be sure

the generator is clean, there might be a small sharp dust particle or something hitting you in the eye, if the tornado chamber is dusty.

- Run fan full speed, and disturb the tornado by slightly disrupting the airflow with your hand. Slowly move your hand in the chamber, perpendicular to airflow, and watch the tornado trying to curl around the disruption to maintain the vortex. You'll be surprised by the strength of the tornado, it may even curl around to horizontal before breaking down instantly.
- Temporarily disconnect the fan from the plexiglass disk, so that the fan now only will be used for blowing air in the PVC tube. Next, connect a vacuum cleaner to the plexiglass air inlet, and run the generator using the fan for blowing and the vacuum cleaner for suction.

## 10.2 Troubleshooting

If the generator doesn't produce any tornado, check these items:

- Check whether the fan is operating;
- Check whether air is blowing out of the PVC tube. Rotating mist is an indication of this;
- Air exit holes in PVC tube don't point in the direction of the front opening (see fig. 18);
- Fan is not powerful enough. Use a fan with higher capacity;
- Fan improperly connected to power supply (in case you have a DC voltage powered fan). You may have connected with polarity the wrong way around;
- PVC tube not closed off at the lower end (air will then flow out and spread about the lower plexiglass disk, destroying air rotation);
- Sock which connects the fan air outlet to the upper end of PVC tube has been twisted, or too much air escapes due to the sock (not being air-tight). Use another sock or tubing (using a tube may make the fan run hot at which no tornado may form, either);
- Ambient air around the generator is not stable. Run the thing indoors, and don't breathe too much in the chamber if the fan is running slowly;
- Fan air intake/output blocked.
- Fan intake at upper plexiglass disk may have a leak. Check, and if necessary, tape it with new tape or use some hot glue (note: I don't think you have this problem, since my fan is not even taped to the disk and my generator seems to work fine);
- Too few air outlet holes in the PVC tube (I had this problem, originally). Don't make any more holes in the tube than noted in the design, as that number will certainly do (6mm in size they must be);

- Something (something large! - you put your cup of coffee *where??*) in the tornado chamber is disrupting the airflow too much. Check, and make sure you use a round PVC tube;
- Your generator has not the right dimensions, or you omitted parts / put parts in wrong position. Review this document to check. Note: the PVC tube is essential to this design, so be sure it is in the right place, with holes pointing in the right direction, and properly connected to the fan outlet;
- Watch the mist which forms in the chamber. If it is rotating, the PVC tube is blowing air allright, and most likely the problem lies in a blocked air intake of the fan, or a fan not working properly (however, it does blow air);
- Too much mist rotating, so the tornado is poorly visible, is mainly due to your mist generator being too powerful. Use a smaller humidifier or set it to low power. (Note: my humidifier has an output of about 15 ml / second (milli-liter, or 1/1000 liter)).
- Else it may be due to excessive blowing of the PVC tube versus air suction at the top. Try to block some holes at the tube and see if this fixes the problem;
- Rotate the PVC tube slightly to see whether it needs reorientation.

With other problems or unsolved problems, don't destroy the thing. You can email me at [edens@weather-photography.com](mailto:edens@weather-photography.com).

## 11 Photos

This section contains some photos of my generator, so you can look and compare how well your generator performs.



Figure 19: The prototype tornado machine in my living room, being tested.

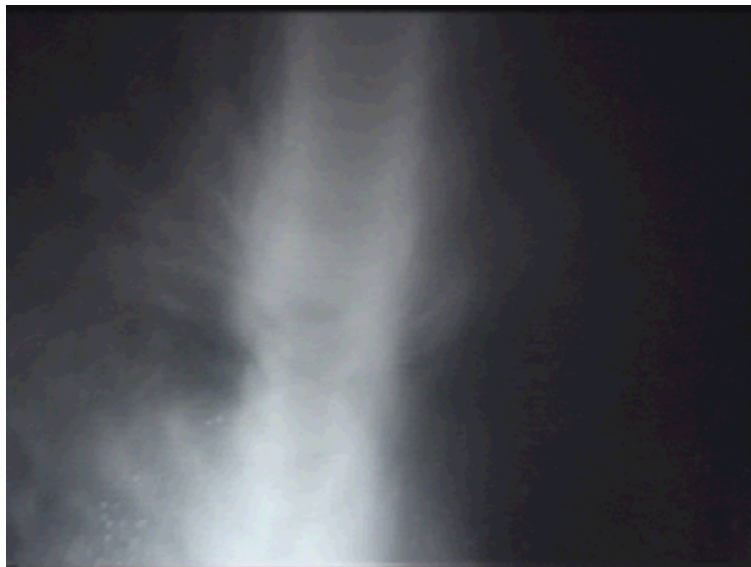

Figure 20: The vortex, showing darker (hollow) core, and mist fragments swirling around it.





Figure 21: Well-developed, relatively strong vortex.

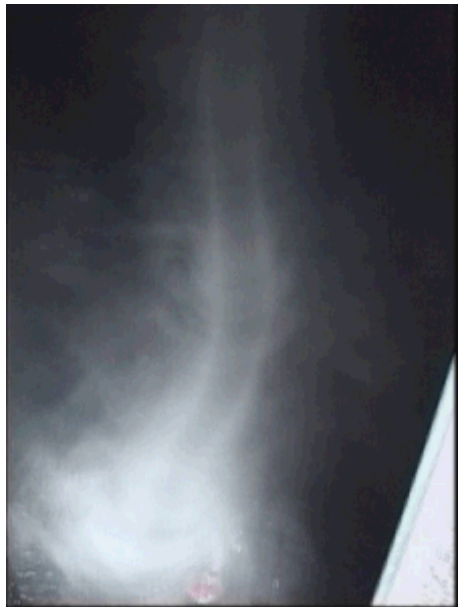

Figure 22: The vortex can be curved by introducing foreign objects into the machine, such as your hand. When the vortex is fully developed, it will maintain itself even by curving around 90 degrees (horizontal) around your hand, before breaking up.



Figure 23: The vortex with the generator running full-speed. The vortex (or the mist machine) should be slightly off-centered, so the mist will not flow directly into the core of the vortex and be sucked away too fast. Having the mist enter at the side of the vortex will make it look more fat, with shear-flow layers of fog visible.



Figure 24: When the mist machine is turned off, the vortex on the water can still be seen; trying to suck up the water. This photo also shows that having a curved base plate is really recommended for the water to run down to the basin. There is a lot of spray water flying around in the machine.



Figure 25: I actually managed to create a double-vortex tornado, with the vortices spinning around each other. This configuration is very hard to get, and the vortices are highly unstable. I made this by adjusting the direction of the PVC tube holes more to the center of the machine, and running full-power.

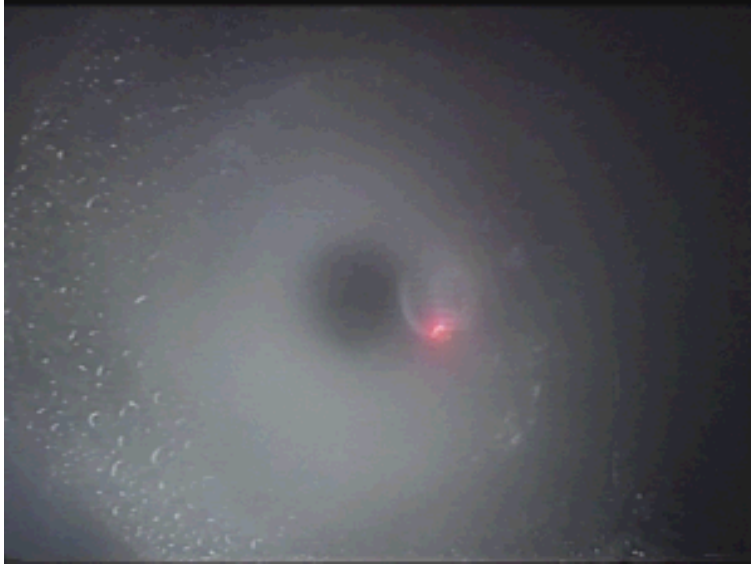

Figure 26: Yes, a tornado vortex *does have* an eye! This photo shows the eye of the vortex, being the hollow core. The core looks clear of mist because air is rising rapidly upwards at the center and removed from the vortex. Photo made by quickly putting the camera in the vortex, and taking a picture, looking down, in the split second before the vortex collapsed. The red light in the middle is the power light of the mist generator.

[NOTES]